

HOW TO PLAY



KONAMI INC. LIMITED WARRANTY

Konami, Inc. warrants to the original purchaser of this Konami software product that the medium on which this computer program is recorded is free from defects in materials and workmanship for a period of ninety (90) days from the date of purchase. This Konami software program is sold "as is"; without express or implied warranty of any kind, and Konami is not liable for any losses or damages of any kind resulting from use of this program. Konami agrees for a period of ninety (90) days to either repair or replace, at its option, free of charge, any Konami software product, postage paid, with proof of date of purchase, at its Factory Service Center.



This warranty is not applicable to normal wear and tear. This warranty shall not be applicable and shall be void if the defect in the Konami software product has arisen through abuse, unreasonable use, mistreatment or neglect. THIS WARRANTY IS IN LIEU OF ALL OTHER WARRANTIES AND NO OTHER REPRESENTATIONS OR CLAIMS OF ANY NATURE SHALL BE BINDING ON OR OBLIGATE KONAMI. ANY IMPLIED WARRANTIES APPLICABLE TO THIS SOFTWARE PRODUCT, INCLUDING WARRANTIES OF MERCHANTABILITY AND FITNESS FOR A PARTICULAR PURPOSE, ARE LIMITED TO THE NINETY (90) DAY PERIOD DESCRIBED ABOVE. IN NO EVENT WILL KONAMI BE LIABLE FOR ANY SPECIAL, INCIDENTAL, OR CONSEQUENTIAL DAMAGES RESULTING FROM POSSESSION, USE OR MALFUNCTION OF THIS KONAMI SOFTWARE PRODUCT.

Some states do not allow limitations as to how long an implied warranty lasts and/or exclusions or limitations of incidental or consequential damages so the above limitations and/or exclusions of liability may not apply to you. This warranty gives you specific rights, and you may also have other rights which vary from state to state.

This game is licensed by Nintendo for play on the

Nintendo® and Nintendo Entertainment System® are Trademarks of Nintendo of America Inc.

Copyright © 1987 Paramount Pictures Corporation. All Rights Reserved.
"TOP GUN" logo is a Trademark of Paramount Pictures Corporation.
Konami Inc. Authorized User. Underlying Source Code © 1987 Konami Inc.
Produced in cooperation with Ocean Software, LTD.

Nintendo
ENTERTAINMENT
SYSTEM®

CONGRATULATIONS!

You now own the authentic Konami home version of the "TOP GUN" video game, one of Konami's many original video hits. We suggest that you read this instruction manual thoroughly before playing the game.

TABLE OF CONTENTS

Introduction/How To Play	4
The F-14 Fighter	5
Controlling Your Fighter in Combat	6
Game Screen	7
Controlling Your Fighter When Refueling/Landing	8
Refuel Mode/Landing Mode ...	9
Levels of Combat	10
Enemy Aircraft	11
Enemy Ships	12
Enemy Ground Forces	13
Taking Care of Your Game	14

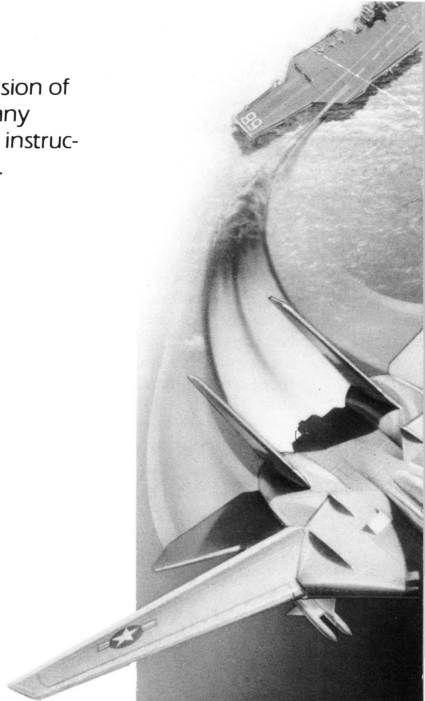

The Impossible Mission?

Snug in the cockpit of a thirty-million dollar war machine, you ease the control stick forward and aim the plane's nose toward the center of the runway. The sun glows orange on the horizon of Fightertown, USA, and all appears peaceful as you complete your second training sortie of the day.

Back inside the flight room, you relax with a hot cup of java, content being the Navy's hottest fighter jock. Suddenly the commander bursts in and gives you a quick salute. His face appears ice cold as he hands you orders marked Top Secret. Breaking the seal, you read the news:

The enemy has invaded vital oil fields and is preparing to advance on our allies. It's navy is fully deployed, and our intelligence warns us they will soon commence an all-out attack on our task force in the region. Adding to the conflict, they have put into operation their latest space base, capable of launching killer satellites on a moments notice.

Your orders, Lieutenant, are to immediately join the carrier USS Enterprise. From there, you will command a squadron of F-14's into battle, with your primary mission being to knock-out the enemy's leading air, sea and land forces, and then to proceed forward, destroying the space base. Remember, the entire free world will be flying with you. If you succeed, World War III will be averted. If you fail, may God help us all. Good Luck.

Signed—Mr. President.

You crumple the orders and eat them. You know what you must do.

How To Play

Strap in, Lieutenant, and take a deep breath. You're about to be catapulted from the deck of a nuclear carrier, within range of enemy forces. And, once in the air, you'll take full control of an F-14 Fighter loaded to the hilt with missiles and cannons.

You begin your mission with 3 aircraft. The game—if you can call war a game—ends when your 3 planes are destroyed, or when you accomplish your mission by taking out the enemy's space base. But, before reaching your ultimate target, you'll confront 3 types of combat—air-to-air combat, air-to-sea combat and air-to-ground combat. After battling through each combat level, you must return to your carrier and nail a pin-point landing to refuel and reload before facing your next deadly challenge.

During the mission your F-14 Fighter can be wiped-out in the following manner. A direct hit by an enemy missile, or a volley of enemy cannon shots, will damage your aircraft. The only way to avoid the catastrophies caused by enemy fire is to be a great pilot. Another problem during these long-range attacks can be empty fuel tanks that'll send you tumbling toward Earth. But to avoid a fuel shortage, you can refuel once in the middle of each level except level 1. (See pages 8 & 9 for refueling instructions)

The "TOP GUN" video game is designed for a solo pilot using CONTROL (1). Your skill as a Naval aviator is determined at the end of your mission by the total number of points accumulated. Points are scored by knocking off enemy forces.

To fire-up your jet engines, press the START button on your CONTROL. Then, just before take-off, select your desired missiles. You can choose from the T-11 HOUND, the T-22 WOLF and the T-33 TIGER. To make your selection, move the curser by pressing the SELECT button. When you've locked onto the missile you want, press the START button.

Once armed, your fighter will automatically launch into the danger zone, and the fate of the free world will instantly rest on your shoulders.

The F-14 Fighter

The F-14 Fighter is the Navy's premier jet fighter. It thrives on air-to-air combat and is considered one of the best dogfighting planes ever flown. With Mach II (+) capabilities and an array of heat-seeking missiles, this aircraft is a plane that makes the best pilots proud.

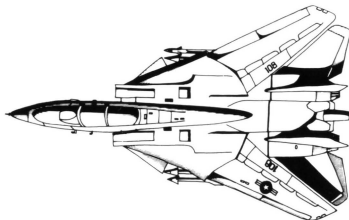

Controlling Your Fighter In Combat

Control Pad

Use the control pad to guide your fighter. It should become like an extension of your hand, because the slightest touch will send you soaring at an incredible speed in whatever direction you point.

B Button

Line up bogeys and then press B button to lock on. When your sights flash red on the target, press B button again. This launches one of your missiles.

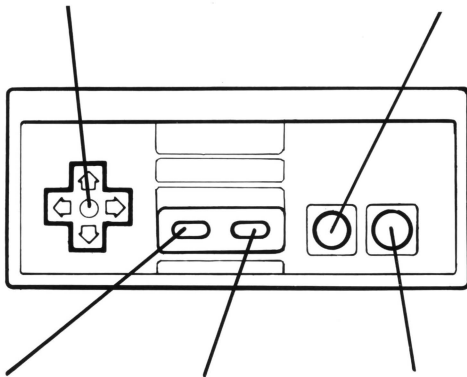

Select Button

Not used during combat.

Start Button

When you run low on fuel or missiles, press the start button to call in a refueling plane. Note, you can only use this tactic one time per combat level. (except combat level 1.)

A Button

Press the A button to fire cannons. Remember, you have an unlimited supply of rounds, so let 'em have it.

The Pilot's-Eye View

Altimeter

The Altimeter reflects your altitude.

Air Speed Indicator

21755
01500
SPEED
MPH

Fuel Meter

Artificial Horizon

The Artificial Horizon indicates the various angles and directions you are flying.

Cannon and Missile Sight

Use to line up and lock onto enemy bogeys.

Multi-function Monitor

The Multi-function Monitor is usually a radar screen, indicating the positions of the enemy. But it also indicates warnings, such as when a bogey is on your tail or when you're flying too low. When in the refueling mode, it indicates the position of the tanker plane's fuel line.

Number of Missiles Remaining

Missile Type Indicator

Damage Indicator

When your plane is hit by enemy cannon shots, the Damage Indicator's red blocks decline. When all of the blocks are eliminated, so are you.

Normal



Left Bank

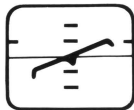

Right Bank



Climb



Dive



Controlling Your Fighter When Refueling And Landing

Control Pad

Guide your aircraft with the control pad to line up with the tanker's fuel line. When landing, use it to maneuver your bird for a pin-point touch down on the carrier deck.

B Button

Press and hold down the B button to decrease your air speed. Release it when you have slowed to a speed you want to maintain.

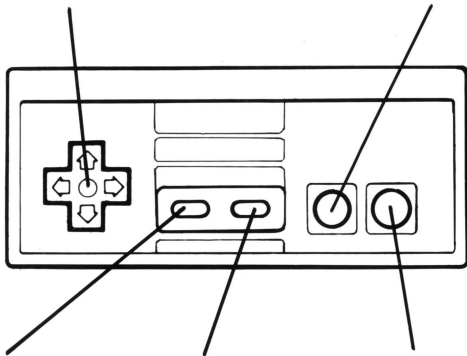

Select Button

Not used during refueling or landing mode.

Start Button

Not used during the landing mode. Used to start the refueling sequence.

A Button

Press and hold down the A button to increase your air speed. Release it when you reach the speed you want to maintain.

Refueling Mode

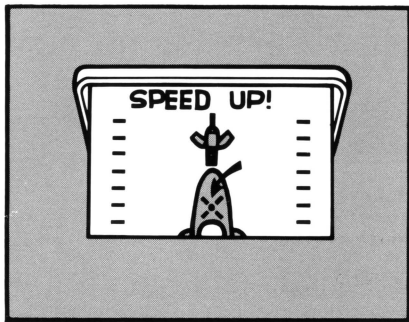

If you run low on fuel, warning messages will alert you to the predicament. When this occurs, be advised to press the START button, calling in a refueling tanker. After the tanker arrives and lowers its refueling boom, guide your aircraft, using the radar screen, into docking position. If the rendezvous is successful, you'll be refueled and ready to fight on. But again remember, only one refueling per combat level. (except level 1.)

Landing Mode

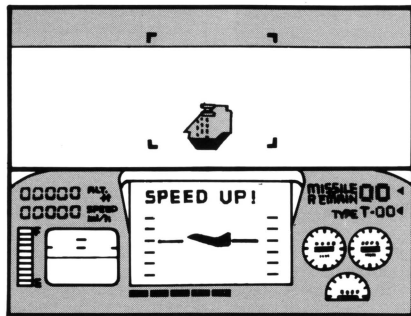

After you ace each of the four combat levels, you must return to your carrier and successfully land. If you make it, damage to your F-14 will be repaired, and you may even receive bonus points. But don't get too cocky! Because any good pilot will tell you that the most nerve racking part of this job is landing a jet fighter on the narrow deck of a Navy flat top. And if you fail, your plane is history. To succeed, your altimeter should read 200, and your air speed should be set at 288.

The Four Levels Of Combat

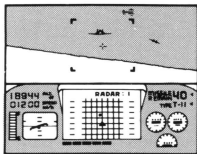

Combat Level One

Combat level one offers you your first taste of dogfighting. It's like an introduction to destruction or a warm-up stage before the heat of battle. But don't take it too lightly or you'll end up splashed at sea.

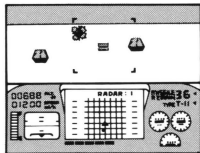

Combat Level Two

Combat level two leads you into the jaws of the enemy's naval prowess. Deadly destroyers, killer cruisers and shifty subs pose threats from below, while enemy planes launched from the carrier, Minsk, attack from above. So aim true, because unless you reach the Minsk and smash her to bits, you won't come close to accomplishing your mission.

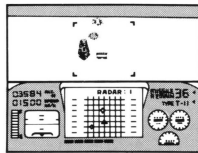

Combat Level Three

Combat level three sends you soaring over enemy shores and into the soul of their ground defenses. You'll need serious poise to avoid guided missiles and nerves of steel to out-maneuver low altitude attack copters. But if you can blast through the main enemy fortress, you'll find yourself on the edge of glory.



Combat Level Four

Nobody ever said glory was for those with weak stomachs, and in combat level four your guts will be tested like never before. The enemy will throw everything they've got at you in all or nothing defense of their pride and joy—the killer satellite space base, which is their means of conquering the heavens and eventually dominating the world.

This is your Waterloo. Spare nothing and return a hero.

Enemy Planes



IL-76 Gargantuan Transport Plane

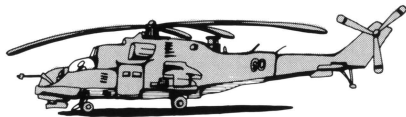

MI-24 Attack Copter

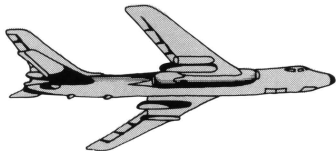

TU-13 Backfire Bomber

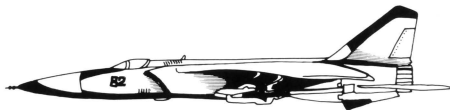

MG-25 Coyote Fighter

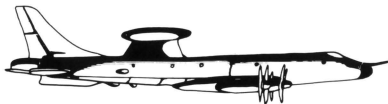

TU-126 Seek and Destroy Craft

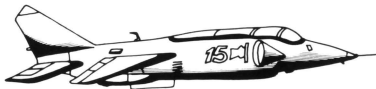

SY-27 Rapid Fire Jump Jet

Enemy Ships

Surface Warfare
Destroyer

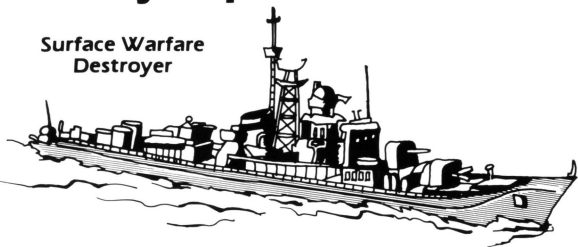

Main Battle
Cruiser

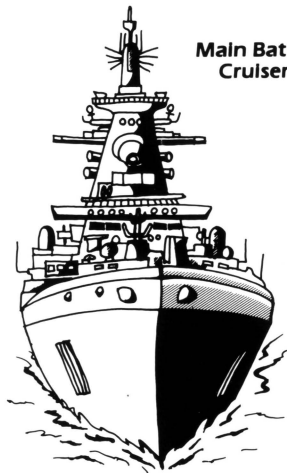

Aircraft Carrier

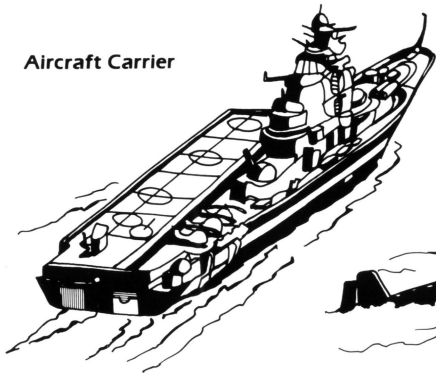

Attack Submarine

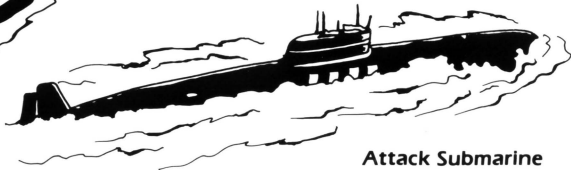

Enemy Ground Forces

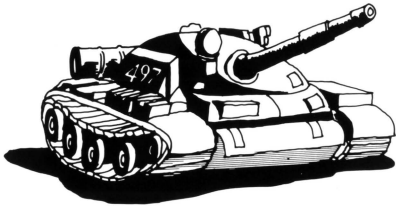

MBT Main Battle Tank

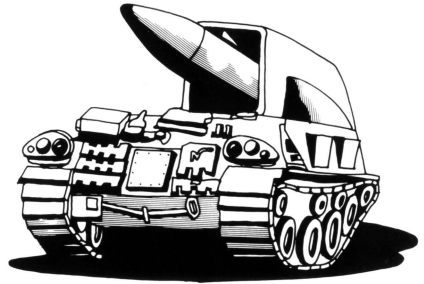

**SK-91 Mobile Cruise
Missile Launcher**

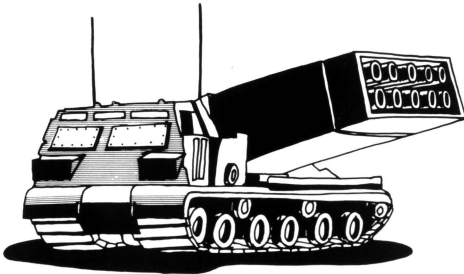

**The Sage Fire
Multiple Rocket System**



**All-Terrain
Advance Troop Transport**

Treat Your Konami Game Carefully

- This Konami Game Pak is a precision-crafted device with complex electronic circuitry. Avoid subjecting it to undue shock or extremes of temperature. Never attempt to open or dismantle the Game Pak.
- Do not touch the terminal leads or allow them to come into contact with water or the game circuitry will be damaged.
- Always make sure your NES Control Deck is SWITCHED OFF when inserting the Game Pak or removing it from the NES Control Deck.
- Never insert your fingers or any metal objects into the terminal portion of the expansion connector. This can result in malfunction or damage.

COMPLIANCE WITH FCC REGULATIONS

This equipment generates and uses radio frequency energy and if not installed and used properly, that is, in strict accordance with the manufacturer's instructions, may cause interference to radio and television reception. It has been type tested and found to comply with the limits for a Class B computing device in accordance with the specifications in Subpart J of Part 15 of FCC Rules, which are designed to provide reasonable protection against such interference in a residential installation. However, there is no guarantee that interference will not occur in a particular installation. If this equipment does cause interference to radio or television reception, which can be determined by turning the equipment off and on, the user is encouraged to try to correct the interference by one or more of the following measures:

- Reorient the receiving antenna
- Relocate the NES with respect to the receiver
- Move the NES away from the receiver
- Plug the NES into a different outlet so that computer and receiver are on different circuits.

If necessary, the user should consult the dealer or an experienced radio/television technician for additional suggestions. The user may find the following booklet prepared by the Federal Communications Commission helpful: How to Identify and Resolve Radio-TV Interference Problems. This booklet is available from the U.S. Government Printing Office, Washington, DC 20402. Stock No. 004-000-00345-4.

SCORES

