

*Mike Tyson's*  
**PUNCH-OUT!!**<sup>®</sup>

**INSTRUCTION BOOKLET**



SPORTS SERIES



Nintendo of America Inc.  
P.O.Box 957, Redmond, WA 98052 U.S.A.

PRINTED IN JAPAN

*Look for this seal on all software and accessories for your Nintendo Entertainment System. It represents Nintendo's commitment to bringing you only the highest quality products. Items not carrying this seal have not been approved by Nintendo, and are not guaranteed to meet our standards of excellence in workmanship, reliability and most of all, entertainment value.*



## 90-DAY LIMITED WARRANTY NINTENDO GAME PAKS

### 90-DAY LIMITED WARRANTY:

Nintendo of America Inc. ("Nintendo") warrants to the original consumer purchaser that this Nintendo Game Pak ("PAK") shall be free from defects in material and workmanship for a period of 90 days from date of purchase if a defect covered by this warranty occurs during this 90-day warranty period, Nintendo will repair or replace the PAK, at its option, free of charge.

### To receive this warranty service:

1. DO NOT return your defective Game Pak to the retailer.
2. Notify the Nintendo Consumer Service Department of the problem requiring warranty service by calling: 1-800-422-2602. Our Consumer Service Department is in operation from 8:00 A.M. to 5:00 P.M. Pacific Time, Monday through Friday. Please Do Not send your Pak to Nintendo before calling the Consumer Service Department.
3. If the Nintendo Service Representative is unable to solve the problem by phone, he will provide you with a Return Authorization number. Simply record this number on the outside packaging of your defective PAK, and return your PAK FREIGHT PREPAID AND INSURED FOR LOSS OR DAMAGE, together with your sales slip or similar proof-of-purchase within the 90-day warranty period to:

Nintendo of America Inc.  
NES Consumer Service Department  
4820-150th Avenue N.E.  
Redmond, WA 98052

This warranty shall not apply if the PAK has been damaged by negligence, accident, unreasonable use, modification, tampering, or by other causes unrelated to defective materials or workmanship.

### REPAIR/SERVICE AFTER EXPIRATION OF WARRANTY:

If the PAK develops a problem requiring service after the 90-day warranty period, you may contact the Nintendo Consumer Service Department at the phone number noted above. If the Nintendo Service Representative is unable to solve the problem by phone, he may advise you of the approximate cost for Nintendo to repair or replace the PAK and may provide you with a Return Authorization number.

You may then record this number on the outside packaging of the defective PAK and return the defective merchandise, FREIGHT PREPAID AND INSURED FOR LOSS OR DAMAGE, to Nintendo, and enclose a money order payable to Nintendo of America Inc. for the cost quoted you. (Repairs may also be charged on a VISA or MASTERCARD credit card.)

If after personal inspection, the Nintendo Service Representative determines the PAK cannot be repaired, it will be returned and your payment refunded.

### WARRANTY LIMITATIONS:

ANY APPLICABLE IMPLIED WARRANTIES, INCLUDING WARRANTIES OF MERCHANTABILITY AND FITNESS FOR A PARTICULAR PURPOSE, ARE HEREBY LIMITED TO NINETY DAYS FROM THE DATE OF PURCHASE AND ARE SUBJECT TO THE CONDITIONS SET FORTH HEREIN. IN NO EVENT SHALL NINTENDO BE LIABLE FOR CONSEQUENTIAL OR INCIDENTAL DAMAGES RESULTING FROM THE BREACH OF ANY EXPRESS OR IMPLIED WARRANTIES.

The provisions of this warranty are valid in the United States only. Some states do not allow limitations on how long an implied warranty lasts or exclusion of consequential or incidental damages, so the above limitations and exclusion may not apply to you. This warranty gives you specific legal rights, and you may also have other rights which vary from state to state.

MEMO

Thank you for selecting the Nintendo Entertainment System® Mike Tyson's Punch-Out!!® Pak.

**OBJECT OF THE GAME/GAME DESCRIPTION**

**Little Mac:** A 17-year-old fighter from the Bronx in New York. He loves nothing better than a tough challenge.

**Doc Louis:** An ex-heavyweight who was a famous hard hitter in the U.S. around 1954.

It all began one day when Little Mac and Doc Louis met by chance. Doc became Mac's trainer, teaching him everything there is to know about boxing. Doc and Mac's story continues over a seemingly endless path, until one day a champion is born.

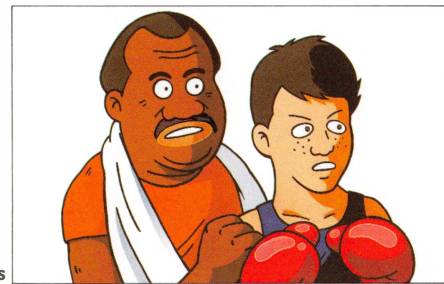

Doc Louis

Little Mac

Please read this instruction booklet to ensure proper handling of your new game and then save the booklet for future reference.

## 1. PRECAUTIONS

- 1) This is a high precision game. It should not be stored in places that are very hot or cold. Never hit it or drop it. Do not take it apart.
- 2) Avoid touching the connectors, do not get them wet or dirty. Doing so may damage the game.
- 3) Do not clean with benzene, paint thinner, alcohol or other such solvents.

## 2. NAMES OF CONTROLLER PARTS AND OPERATING INSTRUCTIONS

### Controller 1

⊕ Control Pad

Controller 1 — Used for all games

Controller 2 — Not used

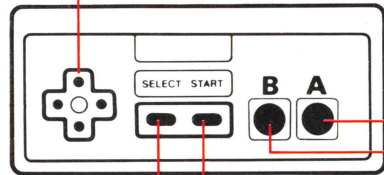

SELECT button      START button

## COMPLIANCE WITH FCC REGULATIONS

This equipment generates and uses radio frequency energy and if not installed and used properly, that is, in strict accordance with the manufacturer's instructions, may cause interference to radio and television reception. It has been type tested and found to comply with the limits for a Class B computing device in accordance with the specifications in Subpart J of Part 15 of FCC Rules, which are designed to provide reasonable protection against such interference in a residential installation. However, there is no guarantee that interference will not occur in a particular installation. If this equipment does cause interference to radio or television reception, which can be determined by turning the equipment off and on, the user is encouraged to try to correct the interference by one or more of the following measures:

- Reorient the receiving antenna
- Relocate the NES with respect to the receiver
- Move the NES away from the receiver
- Plug the NES into a different outlet so that Control Deck and receiver are on different circuits.

If necessary, the user should consult the dealer or an experienced radio/television technician for additional suggestions. The user may find the following booklet prepared by the Federal Communications Commission helpful:

How to Identify and Resolve Radio—TV Interference Problems  
This booklet is available from the U.S. Government Printing Office, Washington, D.C. 20402, Stock No. 004-000-00345-4.

## Basic Technique

1. More of your punches will reach the opponent if you aim where he's not guarding.
2. Little Mac won't be able to punch when he's tired (when he has no hearts), and his opponent will immediately start punching. Dodge his punches and recover hearts.
3. Little Mac's left punch is a little faster than his right, but it's not quite as strong.

## Winning Technique

1. Dodge opponent's punches and then punch back immediately. You'll startle your opponent (his face will show it). This is your chance — punch furiously and you should score.
2. If your opponent comes up on the count of 1 after you've knocked him down, go with an uppercut for a sure knock-down.
3. During an interval: Use the advice of trainer Doc Louis to your best advantage.

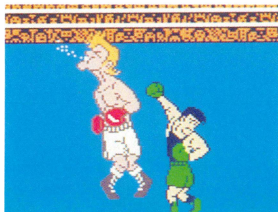
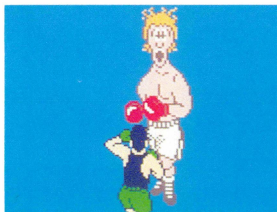

## Before the Game

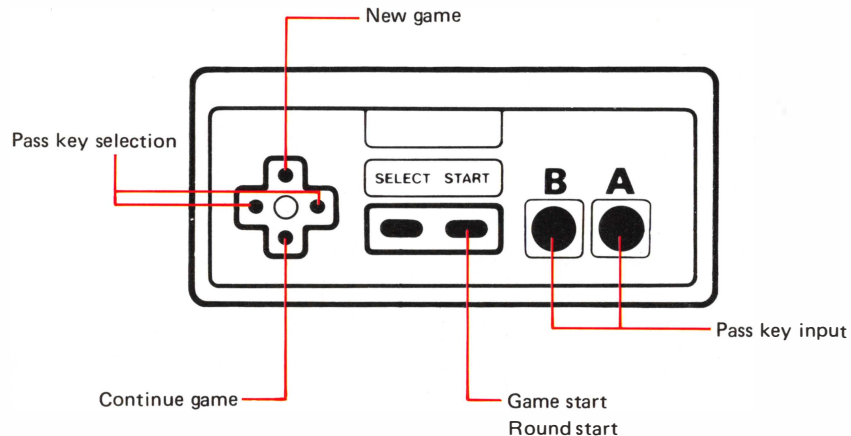

- Press the START button to begin each round.

## During the Game

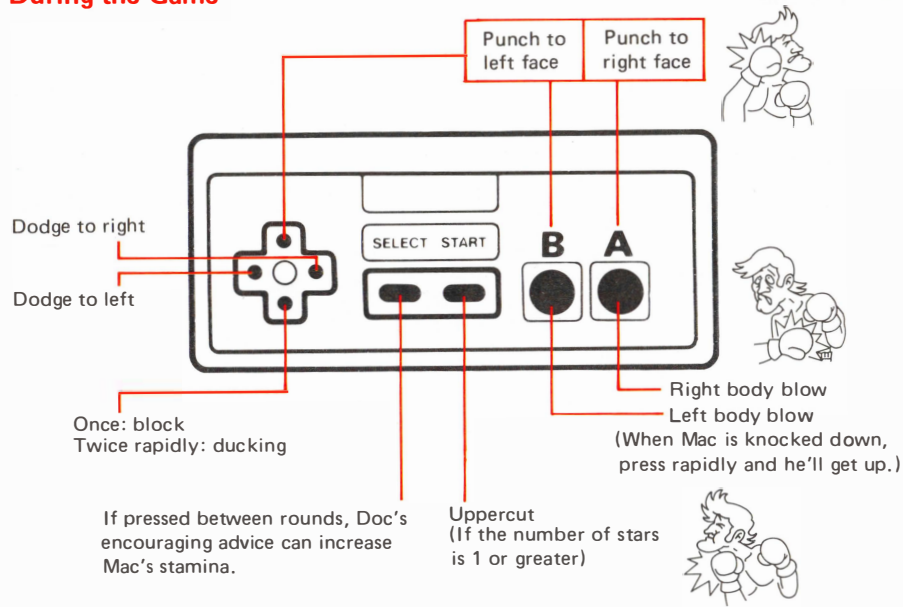

**King Hippo's weak point:** His body; you can knock him out with body punches if you can make him drop his guard.

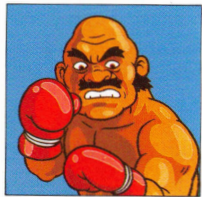

### The Reckless Bald Bull BALD BULL

Ranking: Major circuit, Champion  
Record: 34 wins, 4 losses, 29 KOs  
Place of origin: Istanbul, Turkey  
Age: 36  
Weight: 298 lbs

You'll also meet a bunch of other hard-punching veterans in the ring, including **Piston Honda**, **Don Flamenco**, **Great Tiger**, **Mr. Sandman**, **Soda Popinski**, and **Super Macho Man**. Are you tough enough to go to the top and face **World Champion Mike Tyson**?

## 4. LITTLE MAC'S OPPONENTS

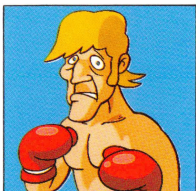

### France's Glass Jaw GLASS JOE

Ranking: Minor circuit, 2nd  
Record: 1 win, 99 losses, 1 KO  
Place of origin: Paris, France  
Age: 38  
Weight: 110 lbs

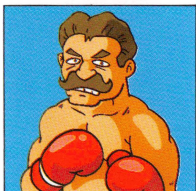

### The German Steel Machine VON KAISER

Ranking: Minor circuit, top  
Record: 23 wins, 13 losses, 10 KOs  
Place of origin: Berlin, West Germany  
Age: 42  
Weight: 144 lbs

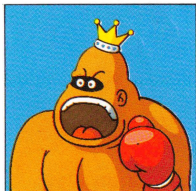

### Tropical Chief KING HIPPO

Ranking: Major circuit, 2nd  
Record: 18 wins, 9 losses, 18 KOs  
Place of origin: South Pacific, Hippo Islands  
Age: ??  
Weight: ???

## 3. HOW TO PLAY

The title will appear when the START button is pressed during the demonstration display. Using the top and bottom of the  $\oplus$  control pad, select either a new game or continued game. If NEW is selected, the game will begin when the START button is pressed. If CONTINUE is selected, use the left and right sides of the  $\oplus$  control pad to select the pass key, then press the A or B button to input the pass key. If the pass key is correct, the game will begin from the boxing circuit corresponding to the pass key.

The title will reappear if the pass key is incorrect. Reselect CONTINUE and input the correct pass key.

- The game will begin with Little Mac ranked in 3rd place on the minor circuit. His ranking will go up each time he wins a match. If he loses, rematch or his ranking will go down.
- Little Mac will give up and retire if he loses a total of three matches.
- The World Video Boxing Association's (WVBA) circuits begin with the minor circuit and continue through the major circuit and the world circuit.



Title Display

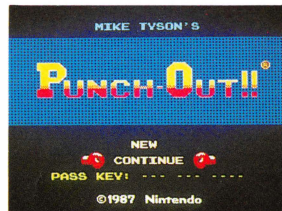

CONTINUE Display

## Pass Keys

- Pass keys will be displayed when Little Mac becomes the champion of the minor circuit and the major circuit. Write down the pass key when it appears. These pass keys can be input to begin the game from the bottom ranking in the major or world circuit, even when the game has been turned off before proceeding.
- Little Mac's match record and circuit level are saved with the pass key until he becomes circuit champion.

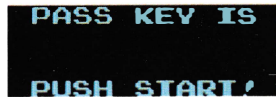

Pass Key Display

## WVBA Rules

- A match consists of three rounds, each of which is three minutes long.
- A boxer is knocked out (KO) if he does not get up within a count of 10 after being knocked down.
- A technical knockout (TKO) is scored if a boxer goes down three times in one round.
- The referee determines the winner according to match points if time runs out in the 3rd round. (Watch out for unfair "hometown decisions" against Little Mac.)

## Screen display between rounds

Doc and Mac's dialogue

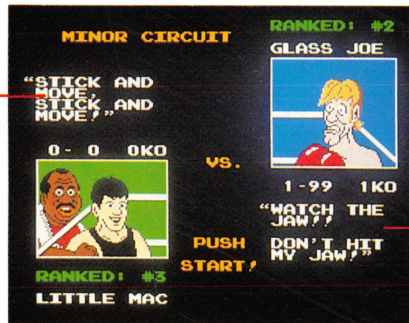

Opponent's dialogue

This dialogue may be a helpful hint to winning the match!



## Screen display before fight

### Mac's Statistics

Little Mac's match record  
Wins - Losses KO's

Circuit name

### Opponent's Statistics

Opponent's ranking

Opponent's name

Opponent's record

Place of origin

Age

Weight in pounds

Little Mac's ranking

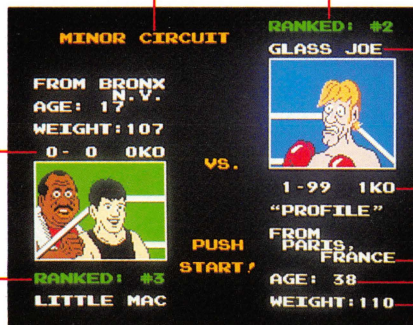

"Defeat all your opponents, and Challenge Mike Tyson in the Dream Fight!!"



### World Champion MIKE TYSON

Ranking: World Champion

Record: 31 wins, 0 losses,  
27 KO's

Place of origin: Catskill,  
New York, U.S.A.

Age: 21

Weight: 220 lbs

(9.1.1987)

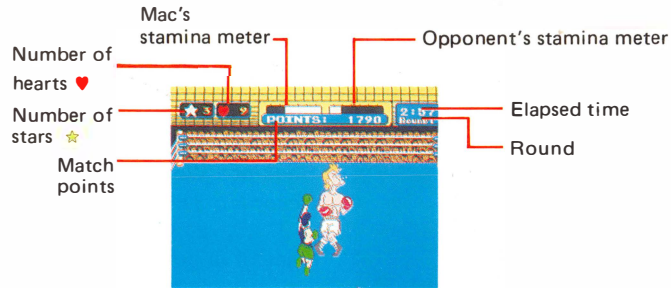

### ♥ Hearts (Mac's fighting spirit) :

Little Mac can punch whenever he has one or more hearts. He will lose a heart each time his opponent blocks or dodges out of the way of one of his punches, and will lose three hearts if he is punched by his opponent. When the number of hearts goes to zero, Little Mac is too tired to punch (he will change color), and must avoid punches by dodging or ducking to gain hearts.

### ★ Stars:

The number of stars is the number of uppercuts that Little Mac can use. When he scores with an effective punch, a star will appear on his opponent's head and the number of stars will increase by one. Little Mac will lose one star if punched by his opponent and will lose all of his stars if he gets knocked down. The maximum number of stars is three.

### Stamina Meters :

These meters show how much stamina Little Mac and his opponent have left. Stamina will drop when a boxer is punched. A boxer will go down if his stamina drops to zero; his stamina will recover when he gets back up (although the amount of recovery depends on the count on which he gets back up).

Once in each match Little Mac can receive advice from his trainer Doc and get a stamina boost if the SELECT button is pressed during an interval.

### Match Points:

Match points are won when Little Mac punches his opponent. Uppercuts and effective punches win the greatest number of match points.

### Elapsed Time:

Shows the lapsed time for the current round.

### Round:

Shows the number of the current round.